

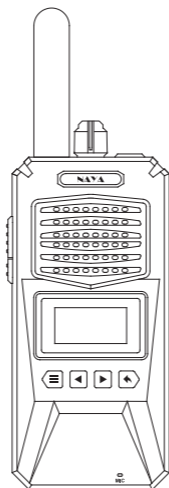

User's manual of intercom handheld **PNI-HT2200**

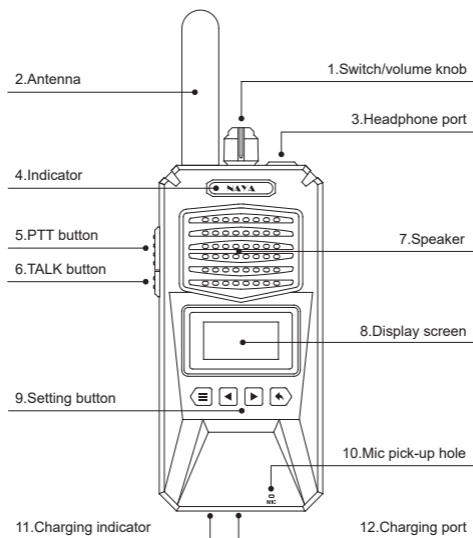

1. Product function



1.1 Switch/volume knob

Turn the knob clockwise, the device is powered on. Continue to turn the knob clockwise, the voice get higher. On the contrary, the voice becomes lower, and then will be off.

1.2 Antenna

It is an important component for signal reception and transmission. Signal will not be received if the antenna is not installed.

1.3 Headphone port

External headphone jack, special customized interface, to buy headphones, you need to contact the manufacturer or dealer to buy the headphone.

1.4 Indicator

Operating status, the indicator light blue and is always on.

Sleep state, the indicator light flashes slowly.

While sending a voice, and the indicator light flashes quickly.

1.5 PTT button

Press the PTT button and keep the mouth to the microphone in 3 to 5CM to speak, release the PTT button, voice transmission end.

1.6 TALK button

Turn on or off the function "continuous calls". Press the TALK button to turn on the continuous call function, and speak without pressing the PTT button. Press the TALK button again, continuous call will be off, voice transmission is over.

1.7 Speaker

Play the voice

1.8 Display screen

Displays the relevant information.

1.9 Setting button

 Menu/confirmation

 Left arrow

 Right arrow

 Return

1.10 Mic pick-up hole

Mic of handheld

1.11 Charging indicator

Light is red while charging, and will get green when fully charged.

1.12 Charging port

Charging jack

2. Using for the first time

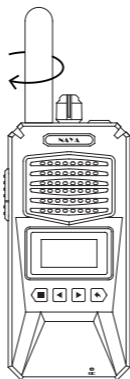

2.1 Step 1:

Install the antenna. Hold the antenna and rotate it clockwise until it is tightened.

2.2 Step 2:

The equipment is powered on. Turn the volume knob clockwise, and the device is powered on. Continue to turn the volume in place.

2.3 Step 3:

After the device is turned on, keep holding the PTT button to speak. Release the PTT button to end the voice transmission.

3. Introduction of display screen

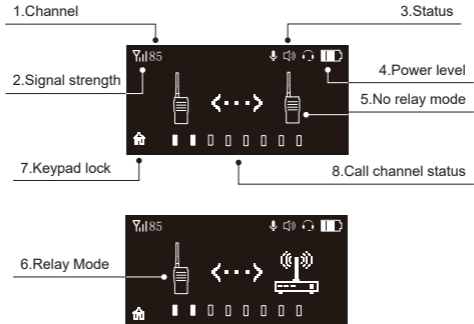

3.1 Channel

Current channel of the handheld

3.2 Signal strength

When the handheld receives a signal from other handheld machines or repeaters, it will show the signal strength of the current handheld or repeater. The higher the signal intensity, the better the signal quality received, on the contrary the worse the signal quality anyway. If no handheld or repeater sending a signal, the signal strength becomes empty.

3.3 Status

Headset icon: speak with headphone while indicating the headset icon, if no headset icon displayed, then using the speaker and MIC call.

Horn icon, showing the horn icon indicating the voice received from other handheld machines. The horn icon is not displayed to indicating that no voice message.

MIC icon, showing MIC icon indicating speaking in PTT or TALK mode. No MIC icon showed, means that voice sending is not turned on.

3.4 Power level

Shows the battery power of the handheld machine. When the battery power is low, the extension will prohibit the voice transmission function. After charging voice transmission can be restored. Low power does not affect the voice reception.

3.5 No relay mode



The No-relay mode shows the two handheld machine icons, indicating that the handheld machine is not connected to any repeater. Communication between the two handheld machines is in the straight-through mode without any repeater. To set fixed channel as networking mode, and no repeaters connected, then the two handheld icons are displayed.

3.6 Relay Mode

Relay mode shows a handheld machine icon and a repeater icon, indicating that the handheld machine is connected to the repeater. The network mode is a fixed channel, under which repeater works, the handheld and repeater icon are displayed.

When the networking mode is set as roaming switching, connect the handheld to the repeater, then the connection icon will be displayed, or disconnection icon will be displayed.







3.7 Keypad lock

The icon on the screen to indicate that the key is in locked state,. Press  first, and then press  to enter the menu.

3.8 Call channel status

This indicates that there are 8 call channels, the icon hollow indicates that the call channel is idle, and the solid icon indicates that the call channel is in use. When all the 8-channel call channels are solid, it means that all the call channels are in use. The handheld with the call function off will be unable to send voice. The voice function can only be turned on until any call channel is idle.

4. Function settings

Press  and  on the standby interface to enter the menu. After entering the menu, press  and  to switch the menu. The menu options include: channel setting, networking mode, and backlight time setting. Select the menu, press  to enter the submenu for parameters modification. After the modification is completed, press  to return to the superior dish, order, and then press  again to exit the menu.

4.1 Channel setting

After entering the menu, select the “Channel Settings” menu (Figure 1 below), and press  to enter the channel parameter modification page (Figure 2 below). After entering the modification page, press left/right to modify the channel. After the modification completes, press the return button to the superior menu, the modification is completed.



Figure 1

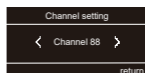

Figure 2

4.2 Backlight time

After entering the menu, select the “backlight time” menu (Figure 1 below), press  to and then enter the backlight time modification page (Figure 2 below). Press left and right for backlight time modification, and press the return key to return to the superior menu after the modification is completed.



Figure 1

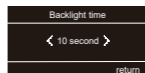



Figure 2

4.3 Networking mode

After entering the menu, select the “networking mode” setting menu (Figure 1 below), press  to enter the networking mode selection page (Figure 2 below). Press left and right to select the fixed channel or roaming switch mode. After the modification completed, press the return key to return to the superior menu.

Fixed channel mode, using the currently set channel, under the channel there is repeater, to which the handheld is automatically connected. If no repeater under the channel, it will automatically change into a straight-through mode.

Roaming switch mode is set when the handheld needs to move among multiple repeaters, to realize the automatic connection to different repeaters. If there is no connection to the repeater in the roaming switching mode, the handheld will constantly search for the repeater, accompanied by prompts, and do not stop the search until finding one repeater.

Handheld should set the list of roaming channels through the configuration software. For example, there are three repeaters, and the corresponding channels are channels 60, 85 and 110, and the handheld roaming list is set up for the corresponding channels 60, 85 and 110.



Figure 1

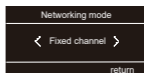

Figure 2

5. Warning

5.1 Don't use this extension in the following scenarios because of interference to electronic or medical devices:

- ◆ Hospitals, around people carrying pacemakers, and near other medical devices.
- ◆ Flammable and explosive places such as gas stations (flammable gas, dust, metal powder, granular powder and other environments).
- ◆ On airplane (and near other electronics that are easily interfered).
- ◆ Any other occasions posted with restrictions or warnings about radio equipment.

5.2 Do not do the following violation operation on the call extension:

- ◆ Do not apply other than the specified voltage on the power supply of the call extension.
- ◆ Do not disassemble or modify the call extension.
- ◆ Do not dip the extension in the water.
- ◆ Do not hit or throw the extension.
- ◆ Do not burn or heat the extension.
- ◆ Do not charge the battery against reverse polarity.
- ◆ Do not weld directly on the battery.

5.3 Other precautions:

- ◆ Do not place the call extension in direct sunlight or near the heater.
- ◆ Do not turn on extension near the TV or radio.
- ◆ Do not modify the battery at will.
- ◆ Please charge with the specified charger.



Please read the manual carefully before using the product

Website: <http://www.nayatec.com>

Manufacturer: Shanghai Naya Intelligence Technology. Co.,Ltd.

Address: No.7001 Zhongchun RD., Minhang district, Shanghai, 201101, China

6. Software installation and connection

6.1 Software download

Log in to the www.nayatec.com website, find the corresponding product model in the technical support, and download the corresponding driver and configuration software according to the tutorial.

6.2 Driver and software installation

Download the installed driver file, the file name is the PL2303_64bit_Installer.exe driver installation package. After successful installation, plug the data cable into the computer and view the port number in the device manager.

Install the downloaded configuration software and complete the software installation according to the installation steps.(Windows7 system installation driver and software is recommended)

6.3 Connection diagram

After the driver and software are installed, connect the handheld machine to the computer as below. Data cable is specially customized, which can not be replaced by charging cable.

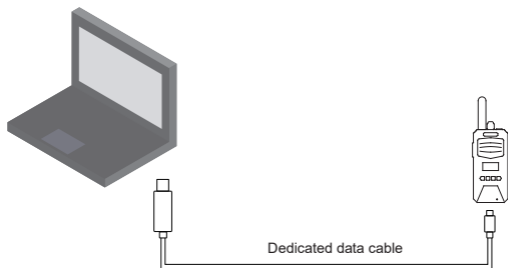

7. Software use

7.1 Open the software

After the installation is complete, run the PniHtCfg.exe file. After opening the software, the following figure is shown. The setting interface is all gray and cannot be edited before selecting and opening the port.

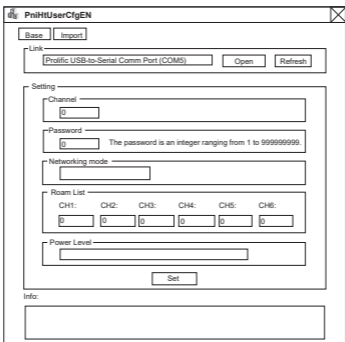

After the setting software is opened, select the corresponding serial port number, and then click to open the port, the software interface becomes editable condition.

- ◆ Turn on the handheld at this time (if it is already turned on, simply turn it off, and then turn it on again). After the handheld is turned on, "connection successful" appears in the software information bar, indicating that the connection is successful.
- ◆ After the handset is successfully connected, it will automatically obtain the parameter information currently set. Modify the parameters according to the needs.
- ◆ After that, click "SET" to complete the setting operation.

7.2 Fixed channel settings

The fixed channel parameter corresponds to the channel setting of the handheld machine. Handheld or repeater under the same channel can communicate with each other.

7.3 Communication password

◆ Under the same channel, the communication password is required to be the same. Under the same channel but with different communication passwords, you cannot communicate with each other. Modifying the communication password of all handhelds and repeaters for communication. This function is often used to prevent eavesdropping with same frequency.

7.3 Networking mode

◆ Fixed channel and roaming switching mode are optional as networking mode. For specific function descriptions, please refer to the handheld network mode setting.

7.4 Roaming list

◆ After the handheld networking mode is set to the roaming switching mode, the roaming channel should be set to correspond the channel list to repeaters channel. For example, the three repeaters in corresponding channels 60, 85 and 110, first handheld roaming channel is set to 60, 2-nd roaming channel is set to 85, 3-rd roaming channel is set to 110, while the other three unused channels.

7.5 Power setting

◆ Wireless transmission power of the handheld can be modified, the greater the gear, the greater the power. Generally used to appropriately improve the call effect in seriously obscured blocks. Wireless signal is prone to the same frequency interference, or the wireless signal penetration through the wall and metal will produce a large attenuation, etc., which will have different effects on the call, so increasing the transmission power can not completely solve the poor call quality.

8. Call diagram

8.1 Call diagram if without repeater

◆ This call mode is the handheld direct-through mode, the handheld can be turned on to realize the call, suitable for a simple space.

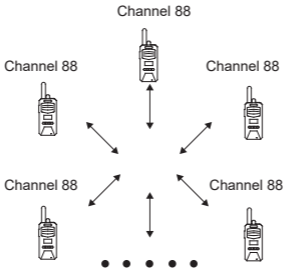

8.2 Single repeater for wireless forwarding call signal

◆ This call mode is repeater forwarding mode, and the handheld sends the voice to other handheld through the repeater.

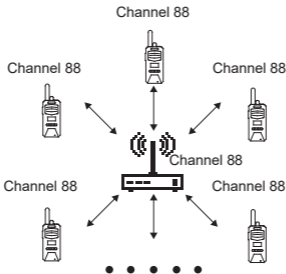

8.3 multi-repeaters networking connection

◆ This call mode is a network call mode, and two or more areas can be connected together through the network to realize multiple mutual call function.

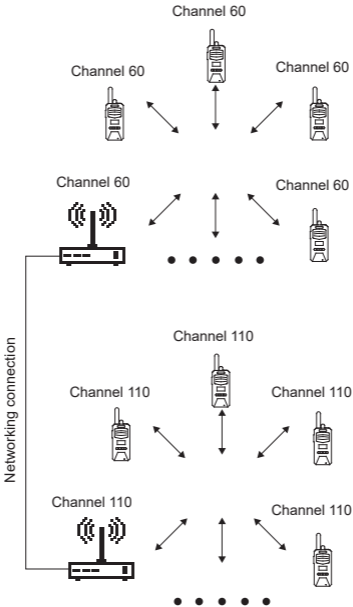

8.4 Multi-repeaters networking for wireless forwarding connection

◆ This call mode is a networked wireless forwarding call mode, and two or more areas can be connected together through the network to realize the mutual call function in multiple places.

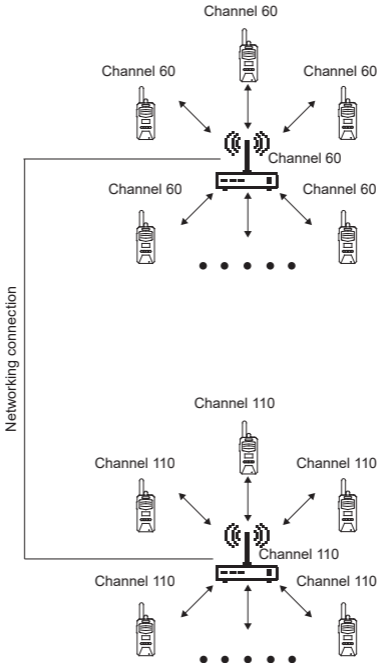

9. Maintenance and cleaning

In order to ensure the good performance of this device and prolong its service life, please be familiar with the following contents for better maintenance and cleaning.

9.1 Maintenance

- ◆ Do not puncture or scratch the device with hard objects.
- ◆ Do not store the device in an environment that contains corrosive electronic circuits.
- ◆ Do not damage the antenna.

9.2 Cleaning

- ◆ Please clean the device regularly, and use a clean and dry towel or brush to remove the dust on the surface of the equipment.
- ◆ If the device casing is dirty, it can be cleaned with neutral detergent and non-woven fabric. Do not use detergent, alcohol or spray which will damage the device, make sure the device is completely dry, otherwise do not use it.

10. Quality commitment and maintenance terms

Naya promises that defects in material or workmanship under normal operating and maintenance conditions of all devices produced by our company, are covered by the warranty service specified below from the date of purchase.

- ◆ Scope and duration of warranty of equipment: 12 months
- ◆ Scope and duration of warranty of headphones: 6 months
- ◆ Warranty application

If you apply for product repair, please be sure to provide the company's product warranty card or a valid purchase invoice as proof of warranty. During the period, the relevant marks of the product shall be kept clean and intact and shall not be torn up.

11. No-warranty policy

If the following conditions occur, it is not covered by the warranty, maintenance and repair should be paid:

- ◆ Failure or damage caused by unauthorized dismantling, repair, modification, misuse, abuse, liquid infeed, accident, use of non-original accessories.
- ◆ Out of warranty.
- ◆ Damage caused by force majeure.
- ◆ Any damage caused by failure to comply with the requirements of the manual and maintenance.
- ◆ The performance failure of products and accessories is caused due to human reasons.
- ◆ Malicious damage to warranty card content or fuselage information, including blurred damage, self-tearing and tampering, etc.
- ◆ Other failures and damage caused by problems such as design, manufacture, and quality of the device.
- ◆ Products sold to Chinese mainland only be under national joint warranty service in Chinese mainland.

12. Warranty card

◆ In order to protect your rights and interests, please fill in it carefully and keep it properly as a certificate for maintenance.

Reseller information			
Model		Sales date	
Reseller		Contact telephone or E-mail	
User information			
User		Contact telephone	
Address		E-mail	